



DFMZ
DESIGN FILTRATION MICROZONE



POLYPROPYLENE CASEWORK
ПОЛЪПРОПЪЛЕНЕ СЪСЕМОВЪК

BASE CABINETS

STANDARD FEATURES

- METAL FREE CONSTRUCTION
- BODY CONSTRUCTION IS 1/2" THICK, CHEMICAL RESISTANT, WHITE POLYPROPYLENE WITH WELDED SEAMS
- WORK SURFACES ARE 3/4" THICK WHITE POLYPROPYLENE, 30" DEEP WITH A 4" HIGH BACK SPLASH
- 36" HIGH STANDARD HEIGHT
- ADJUSTABLE/REMOVABLE SHELF WITH EVERY CUPBOARD CABINET
- BLACK PLASTIC HARDWARE
- ADJUSTABLE LEG LEVELLERS
- BACK ACCESS PANEL TO REAR CHASE

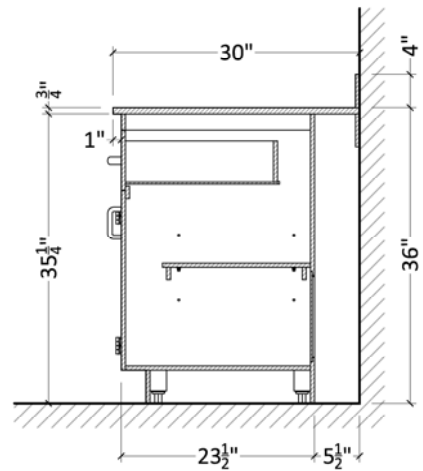

TYPICAL CABINET SECTION

18" WIDE BASE CABINETS

BC18-1000	BC18-1001	BC18-1002	BC18-1003	BC18-1004	BC18-1005	BC18-1006	BC18-1007





24" WIDE BASE CABINETS

BC24-2000	BC24-2001	BC24-2002	BC24-2003	BC24-2004	BC24-2005	BC24-2006	BC24-2007	BC24-2500

36" WIDE BASE CABINETS

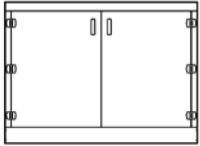
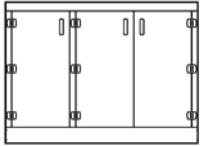
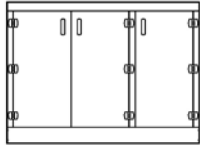
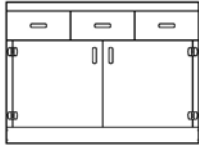
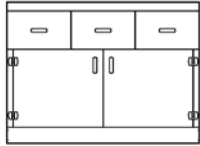
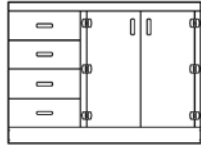
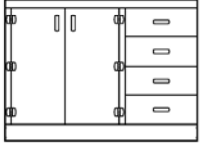
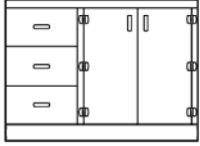
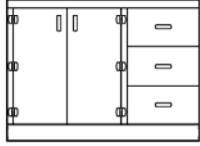
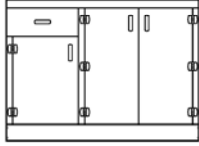
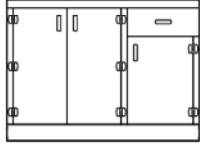
BC36-3000	BC36-3001	BC36-3002	BC36-3003	BC36-3004	BC36-3005
BC36-3006	BC36-3007	BC36-3008	BC36-3500	BC36-3501	BC36-3502

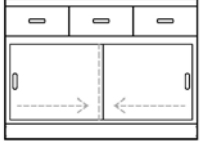
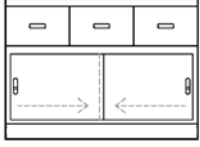
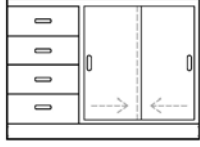
48" WIDE BASE CABINETS

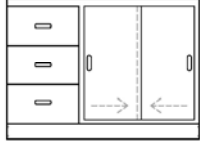
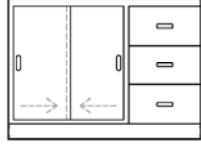
					
BC48-4000	BC48-4001	BC48-4002	BC48-4003	BC48-4004	BC48-4005
					
BC48-4006	BC48-4007	BC48-4008	BC48-4009	BC48-4010	BC48-4500
					
BC48-4501	BC48-4502	BC48-4503	BC48-4504	BC48-4505	BC48-4506

SPECIALTY PIECES

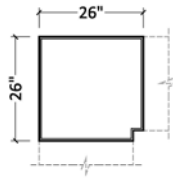
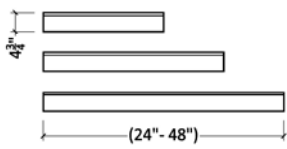
 <p>CORNER CABINET:</p> <ul style="list-style-type: none"> • TOP VIEW OF CORNER CABINET • PROFILE MATCHES TYPICAL CABINET <p>BC00-0001</p>	 <p>"OPEN AREAS":</p> <ul style="list-style-type: none"> • 3/4" WORK SURFACE WITH RIBS, SUPPORTED BETWEEN TWO CABINETS • WIDTHS BETWEEN 24" AND 48" <p>BC00-0100</p>
---	---

SINKS AND ACCESSORIES

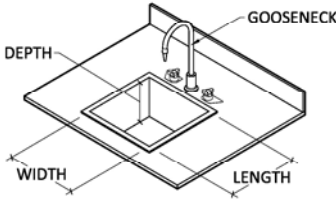
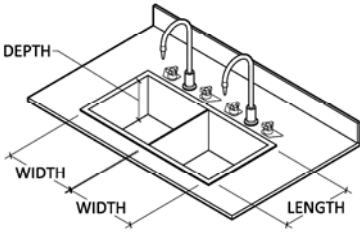
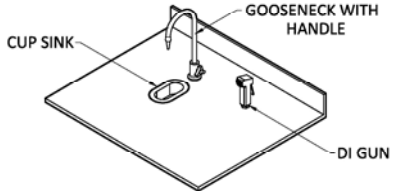
 <p>BC00-0200</p> <p>SINGLE SINKS:</p> <ul style="list-style-type: none"> • NATURAL COLOUR POLYPROPYLENE, WITH WELDED SEAMS • WIDTH, 6" - 18" • LENGTH, 6" - 14" • DEPTH, 6" - 12" • 1.5" NPT DRAIN CONNECTION 	 <p>BC00-0300</p> <p>DOUBLE SINKS:</p> <ul style="list-style-type: none"> • NATURAL COLOUR POLYPROPYLENE, WITH WELDED SEAMS • DUAL FAUCETS • WIDTH, 6" - 18" • LENGTH, 6" - 14" • DEPTH, 6" - 12" • 1.5" NPT DRAIN CONNECTION 	 <p>ACCESSORIES:</p> <p>BC00-0400 CUP SINK, BLACK RESIN, 3"x7", 1.5" NPT DRAIN CONNECTION</p> <p>BC00-0401 DI GUN WITH TRIGGER, NYLON</p> <p>BC00-0402 GOOSENECK FAUCET, POLYPROPYLENE</p> <p>BC00-0403 GOOSENECK FAUCET WITH HANDLE, POLYPROPYLENE</p>
---	---	---

WALL CABINETS

STANDARD FEATURES

- METAL FREE CONSTRUCTION
- BODY CONSTRUCTION IS ½" THICK, CHEMICAL RESISTANT, WHITE POLYPROPYLENE WITH WELDED SEAMS
- ADJUSTABLE/REMOVABLE SHELF WITH EVERY CABINET
- BLACK PLASTIC HARDWARE ON SWING DOORS

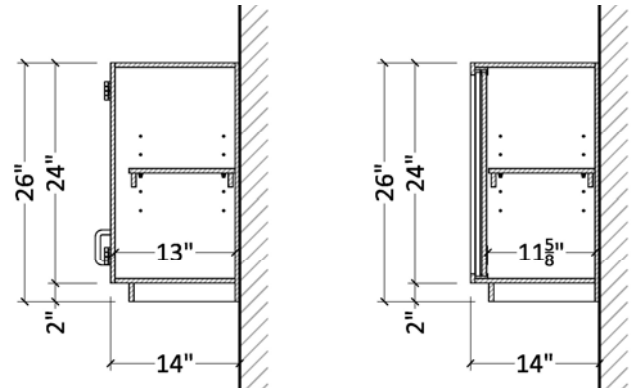

TYPICAL CABINET SECTIONS

24" WIDE WALL CABINETS

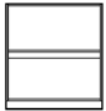

WC24-01



WC24-02



WC24-03

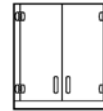

WC24-04

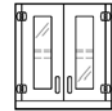

WC24-05

30" WIDE WALL CABINETS



WC30-01

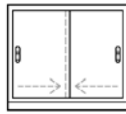

WC30-02

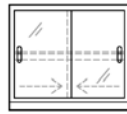

WC30-03

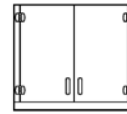

WC30-04

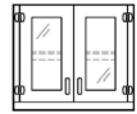

WC30-05

36" WIDE WALL CABINETS

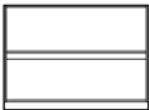

WC36-01

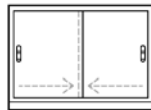

WC36-02

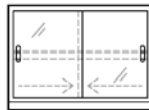

WC36-03

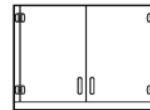

WC36-04

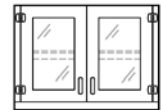

WC36-05

For custom cabinetry please contact a Design Filtration Microzone sales representative!



DFMZ
DESIGN FILTRATION MICROZONE